



Simulation of Super Charm-Tau Inner Tracker, choice of options

Budker Institute of Nuclear Physics

L. Shekhtman, A. Sokolov, Vijayanand KV,
T. Maltsev

6 December 2018
Orsay, France

Detector for Super Charm-Tau Factory

Collider parameters

- Luminosity $10^{35} \text{ cm}^{-2} \text{ s}^{-1}$
- Energy range 2 — 7 GeV

1 Inner Tracker

2 Drift chamber

3 FARICH identification system

4 Calorimeter on pure CsI

5 Superconducting coil

6 Yoke with a muon system

Tasks

- Rare decays
 - τ lepton
 - D mesons
 - D^0 — anti- D^0 oscillations
- Search for $\tau \rightarrow \mu \gamma$

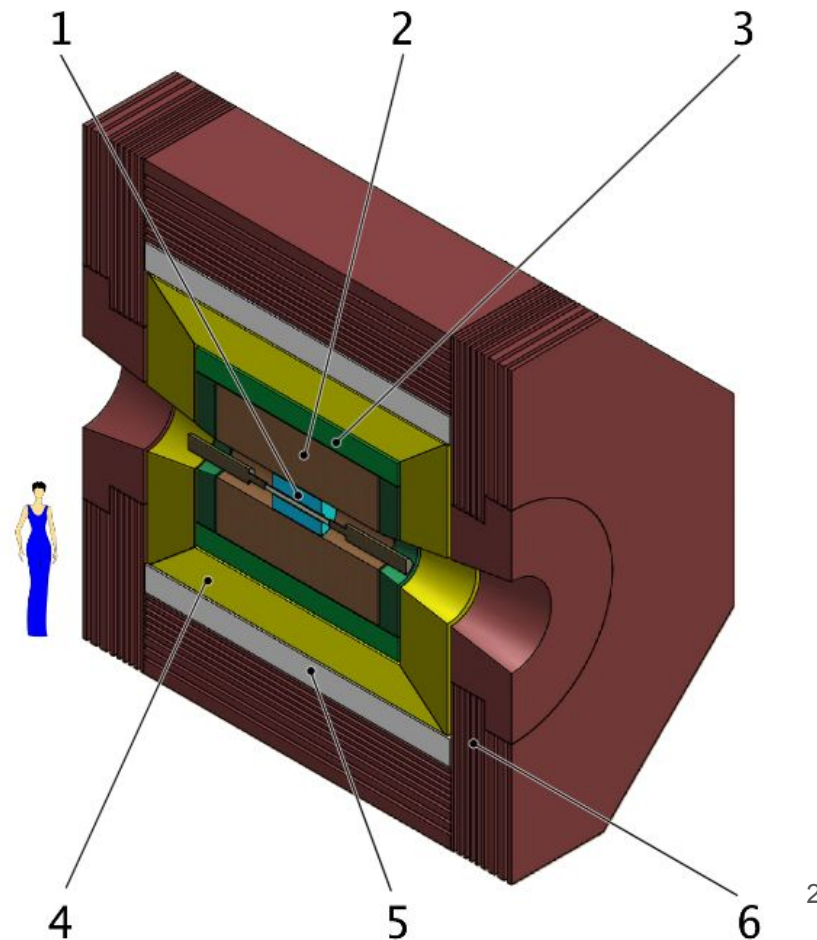

Inner Tracker (IT)

Tasks

- Detect secondary vertices from the decays of short-lived particles such as K_S^0 or Λ
- Complement the drift chamber in measuring the momenta
- Soft π^\pm mesons registration (with momenta < 100 MeV/c)

Requirements

- Handle with high particle flux - luminosity of 10^{35} $\text{cm}^{-2} \text{s}^{-1}$

Soft hadrons registration is required

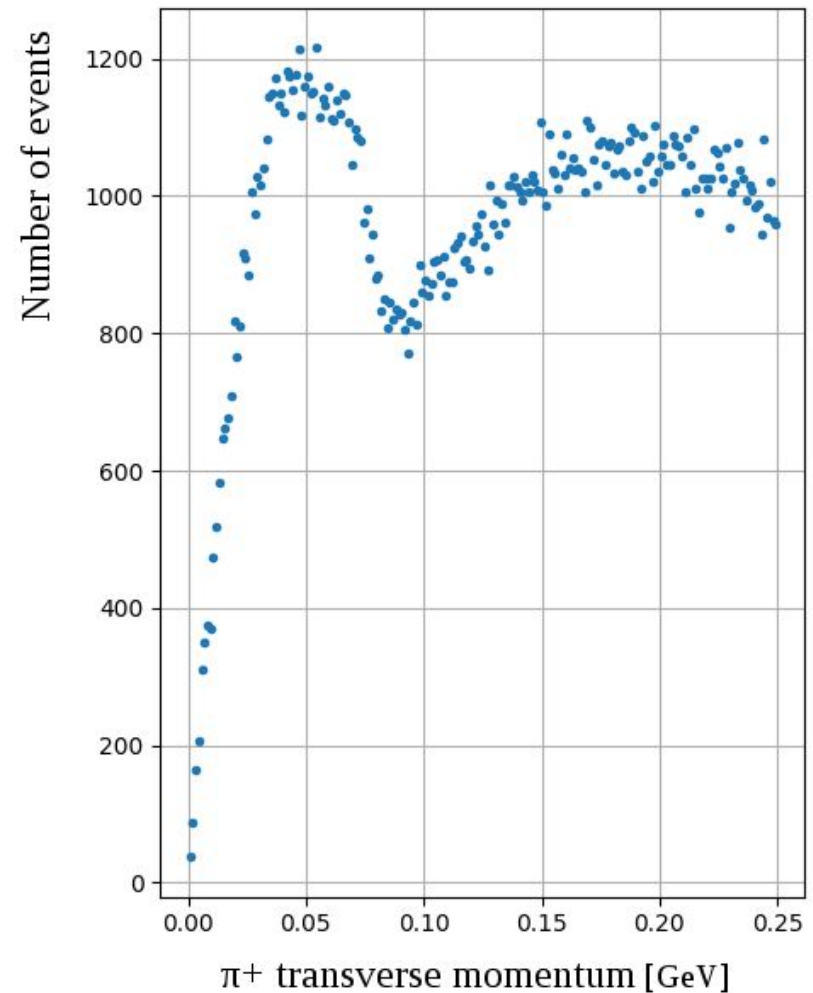

Simulation of π^+ transverse momentum distribution in $e^+e^- \rightarrow DD^*$ (V. Vorobyev)

Inner Tracker

- Located between vacuum chamber and drift chamber
- Detection solid angle up to 98%
- Cylinder
 - Length 60 cm
 - Inner diameter 3 cm
 - Outer diameter 40 cm

Simulation in DD4hep
dd4hep.web.cern.ch

Options

- Cylindrical silicon strip 4-layer detector (Si-strips)
- Cylindrical GEM (Gas Electron Multiplier) (CGEM) 4-layer detector
- Time Projection Chamber (TPC)

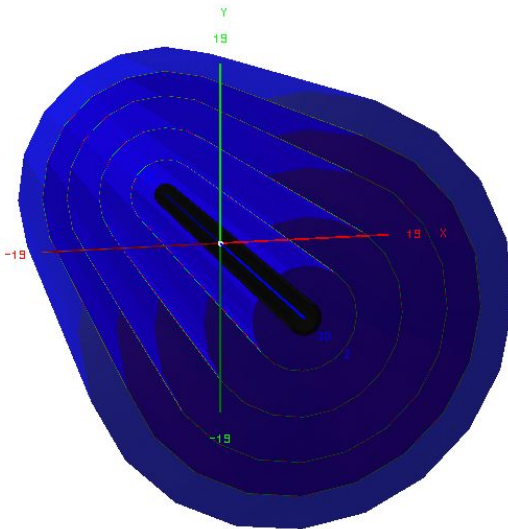

Si-strips

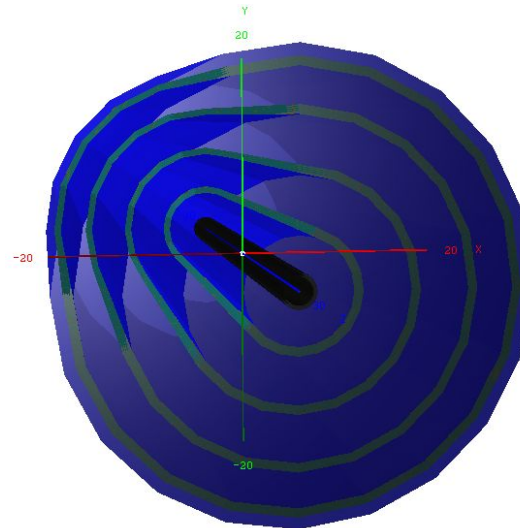

CGEM

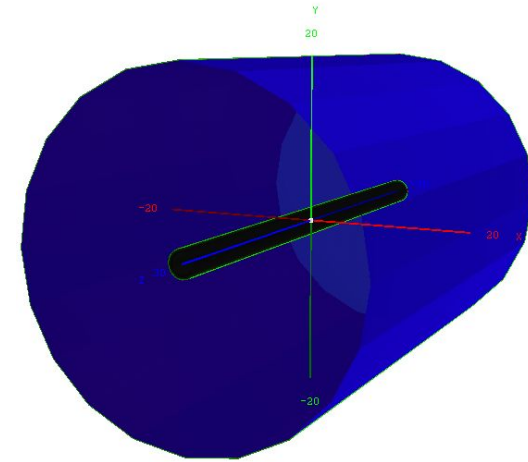

TPC

Inner Tracker

Options

- Cylindrical silicon strip 4-layer detector (Si-strips)
- Cylindrical GEM (Gas Electron Multiplier) (CGEM) 4-layer detector
- Time Projection Chamber (TPC)

| option/subsystem | Materials | Thickness (X0) |
|------------------|---|----------------|
| Vacuum Pipe | 3 mm Be + 0.5 mm paraffin | 1% |
| TPC | 2x(1mm glass fiber (G10) + 0.1 mm teflon + 15 μ m copper) | 1% |
| CGEM | 4x(0.25 mm kapton + 40 μ m copper) | 1.2% |
| Si-strips | 4x(0.32 mm Si + 0.4 mm carbon fiber) | 2.4% |

Vacuum pipe

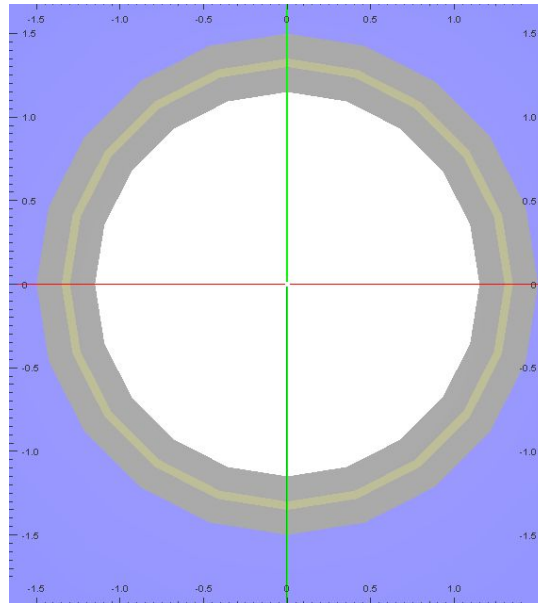

Inner Tracker

Si-strips

- 4 layers of 0.32 mm Si + 0.4 mm carbon fiber
- Gas - air
- Magnetic field 1.5 T
- Air is also outside the Inner Tracker (in all simulations)
- Pions with different momenta were gun perpendicular to beam axis

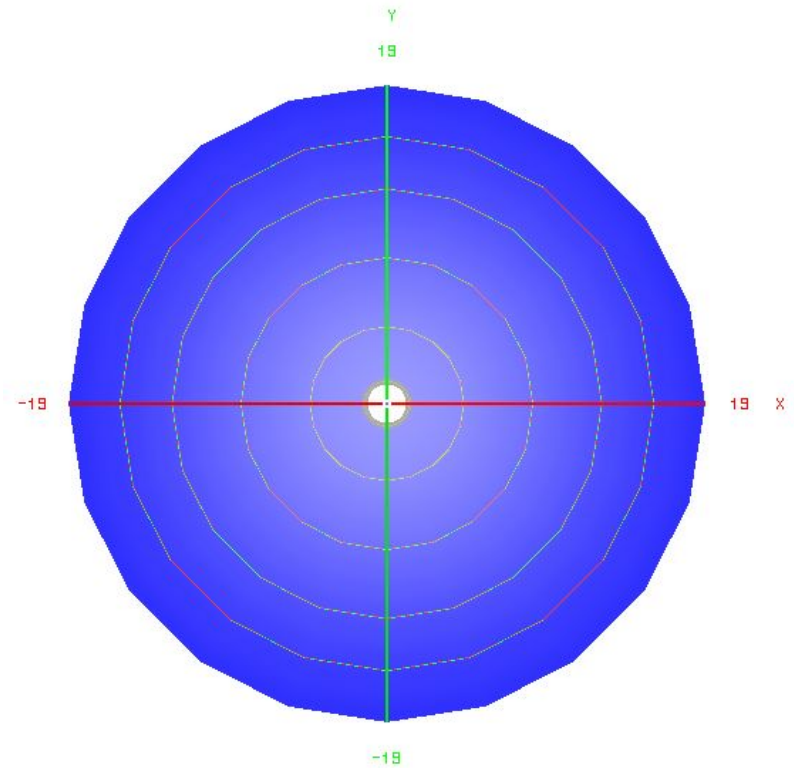
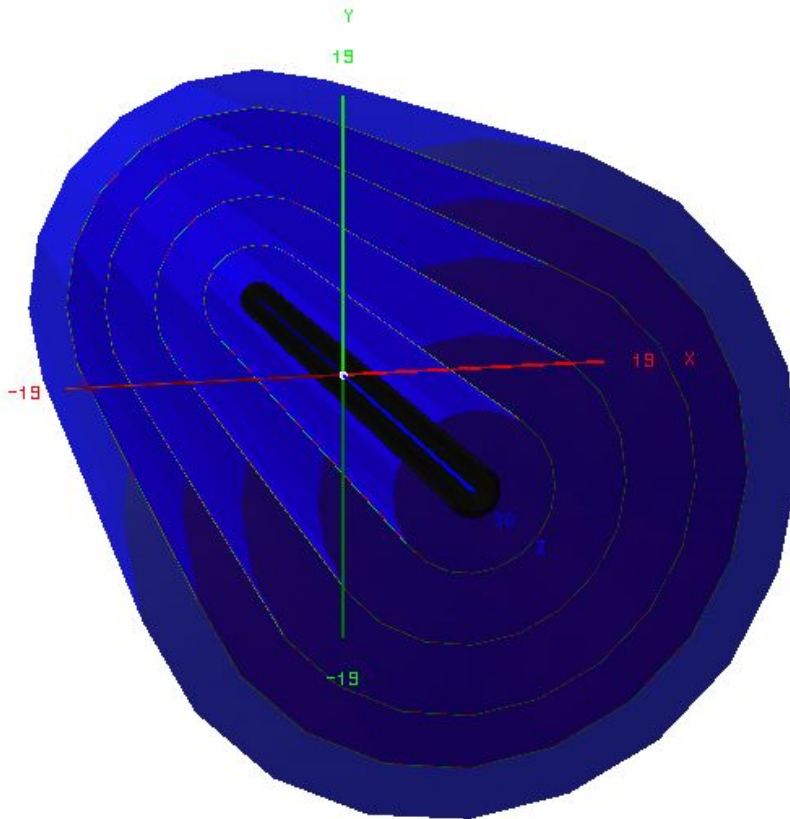

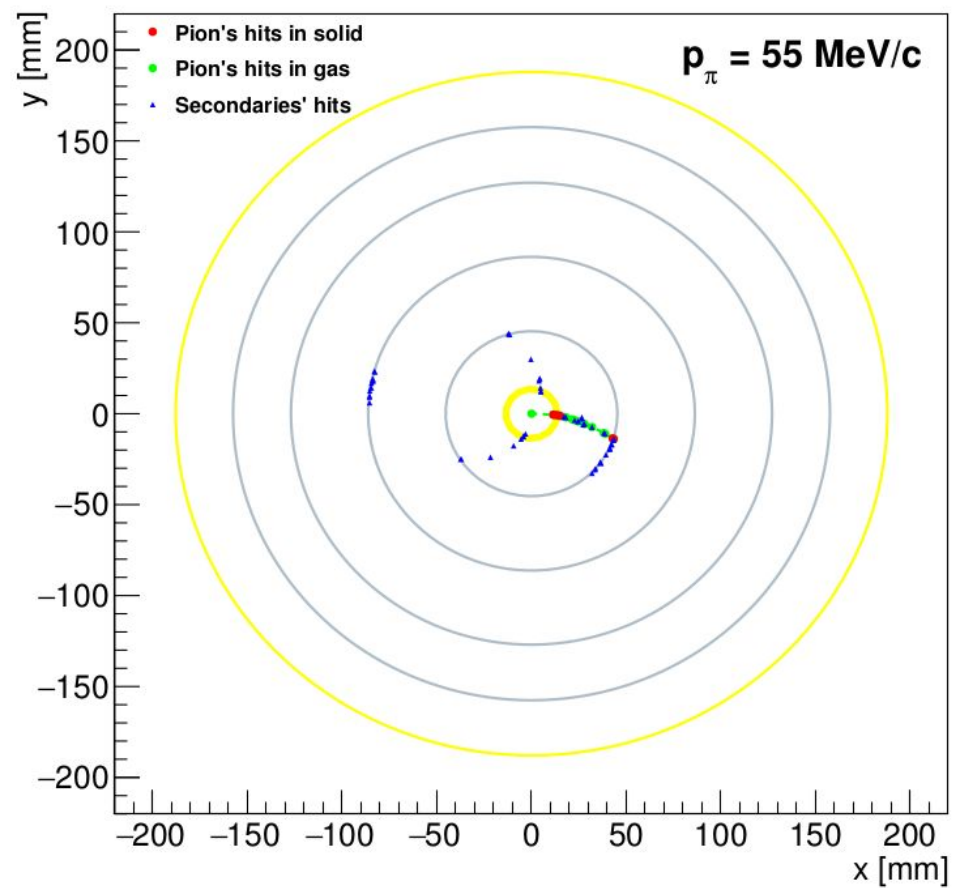
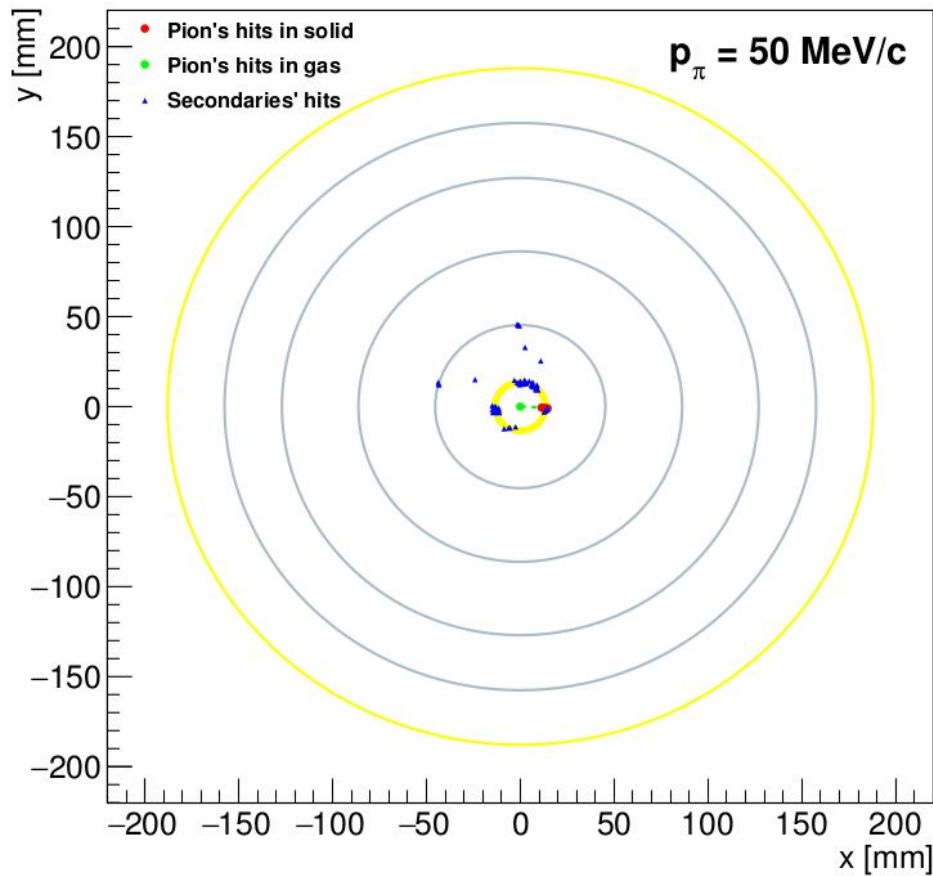

- Pions with momenta less than 50 MeV/c do not pass through the beampipe
- Starting from $p_\pi = 55 \text{ MeV/c}$ the first layer is reached by pions

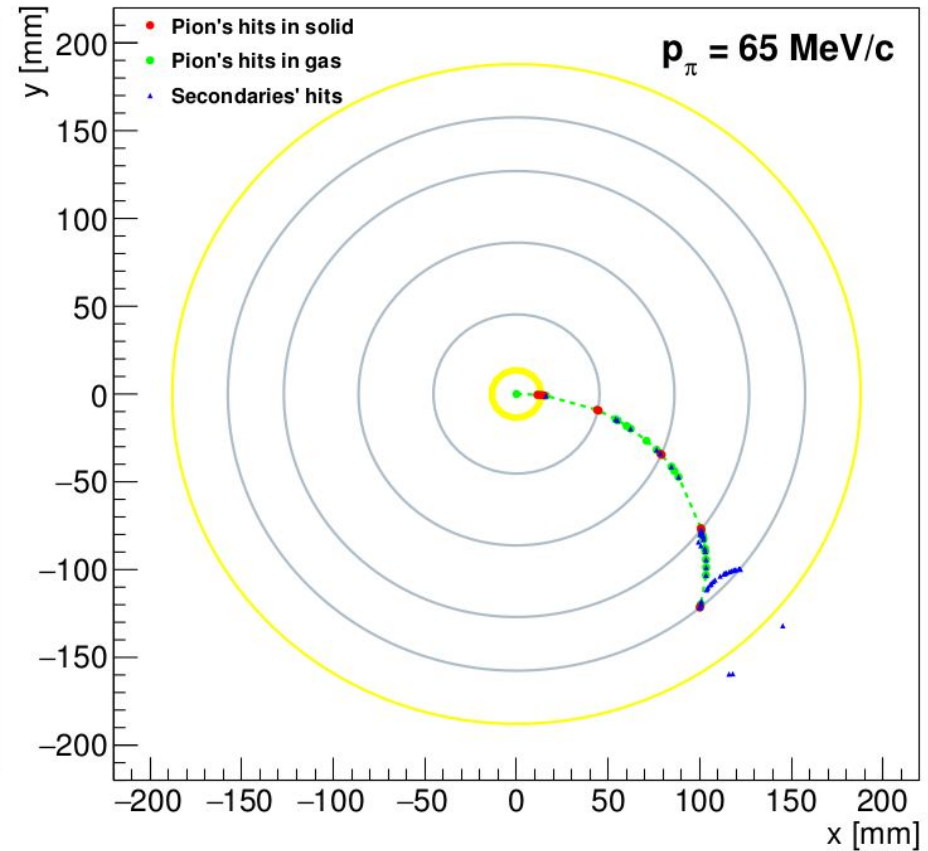
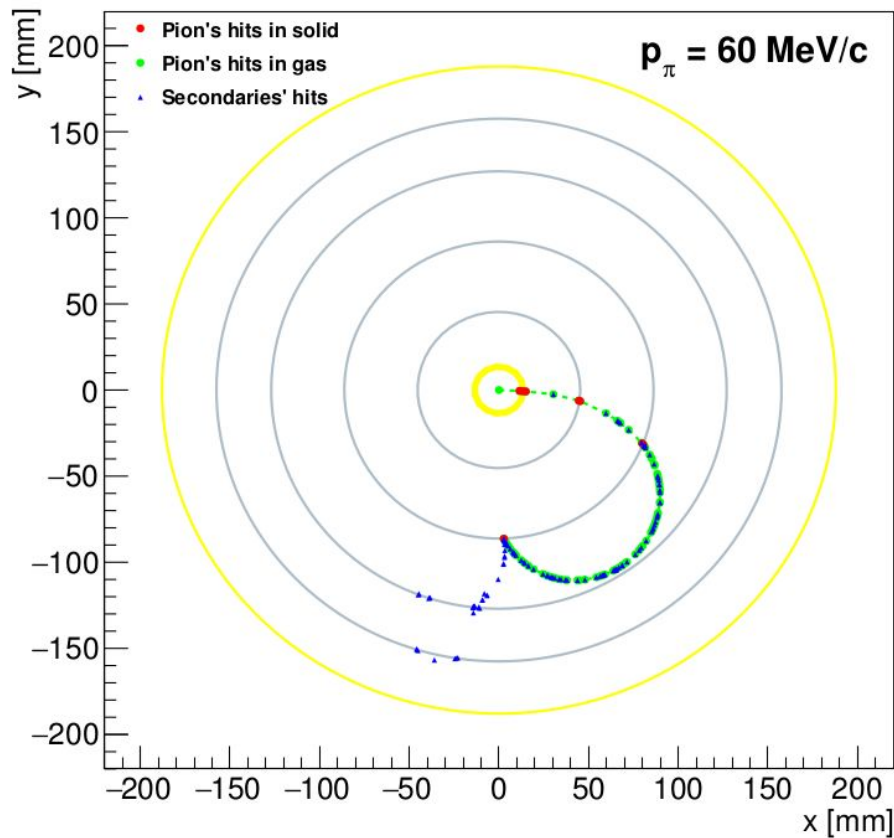

- Pions with momenta 60 MeV/c pass through two layers
- Starting from $p_\pi = 65 \text{ MeV/c}$ the all 4 layers are reached by pions

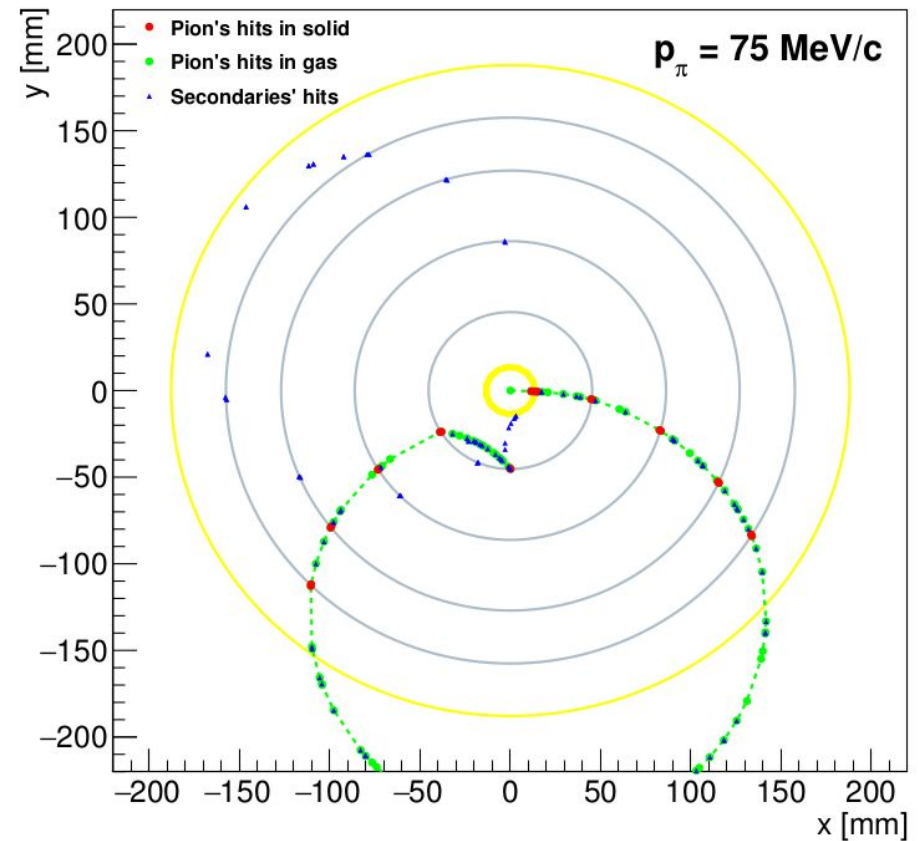
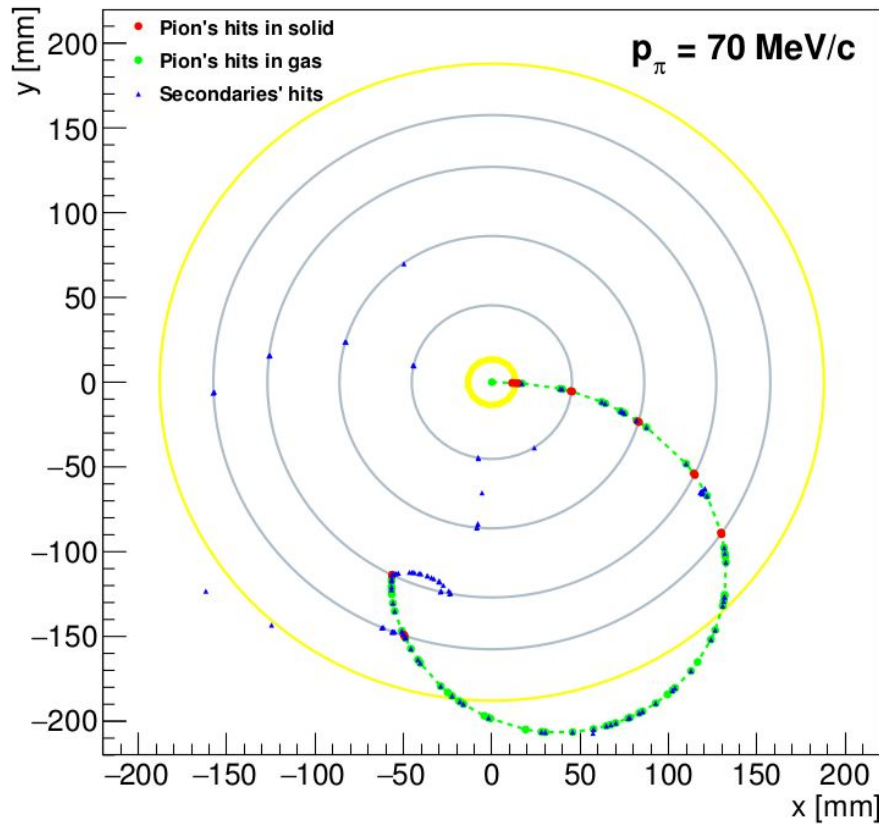

- If air is placed outside IT, pions return back with momentum around 70 MeV/c
- Pions with $p_{\pi} = 75 \text{ MeV}/c$ cross layers twice

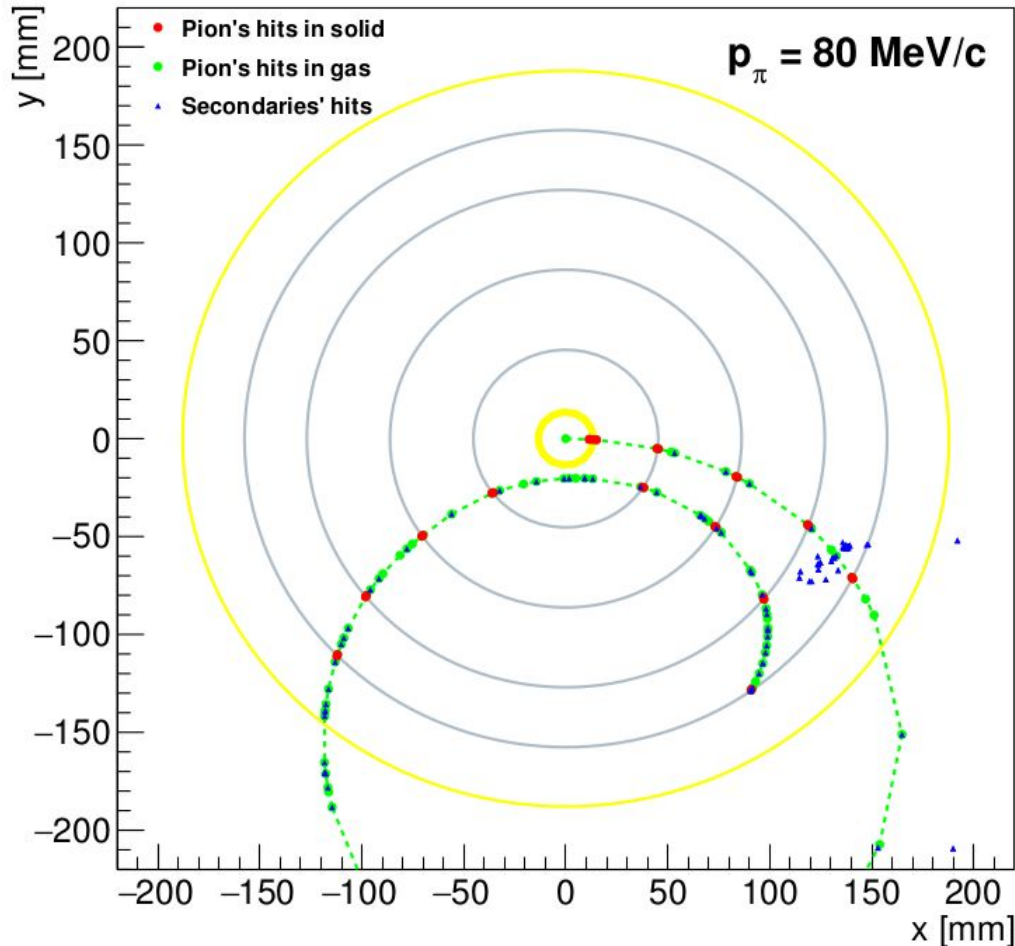

The reconstruction of pions with hits in 4 layers for Si-strips option of Inner Tracker is possible for pions with momentum, greater than 65 MeV/c

- 4 layers of GEMs
 - GEM gas Ar(75%)-CO₂(25%)
 - GEM gaps 3+1.5+1.5+1.5 [mm]
 - GEM holes are accounted by decreasing density in copper and kapton (factor 0.8)
- Gas outside GEMs is air
- Magnetic field 1.5 T
- Pions with different momenta were gun perpendicular to beam axis

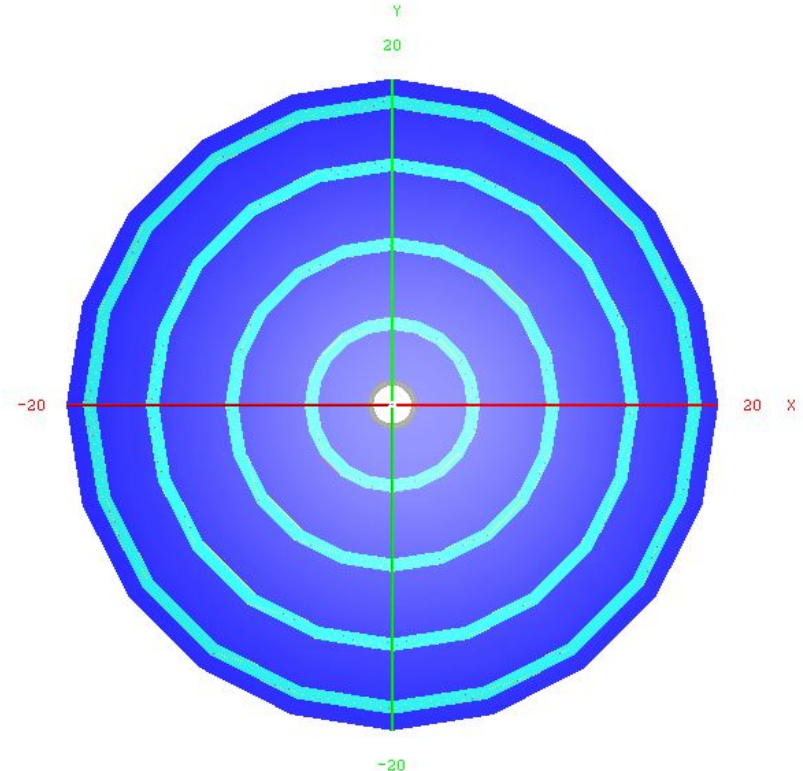
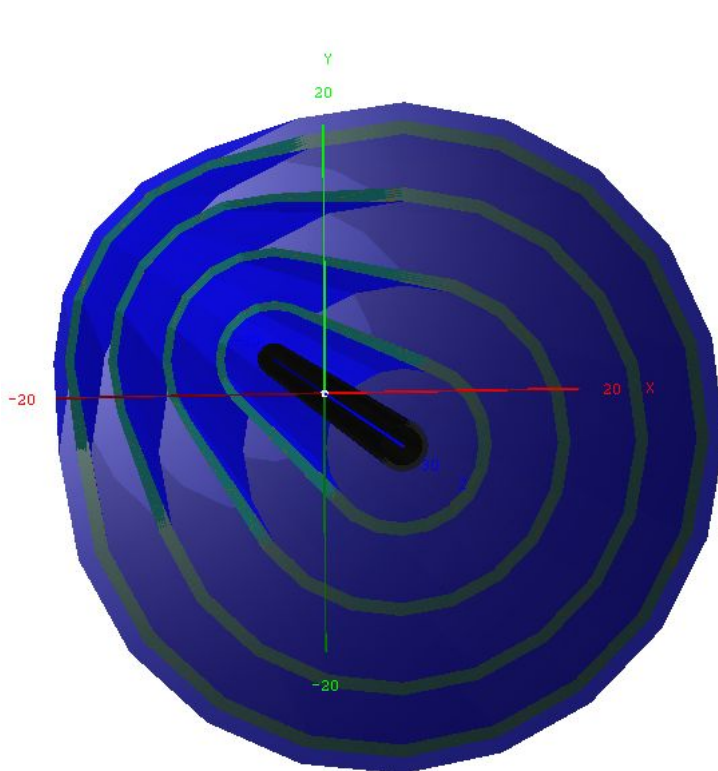

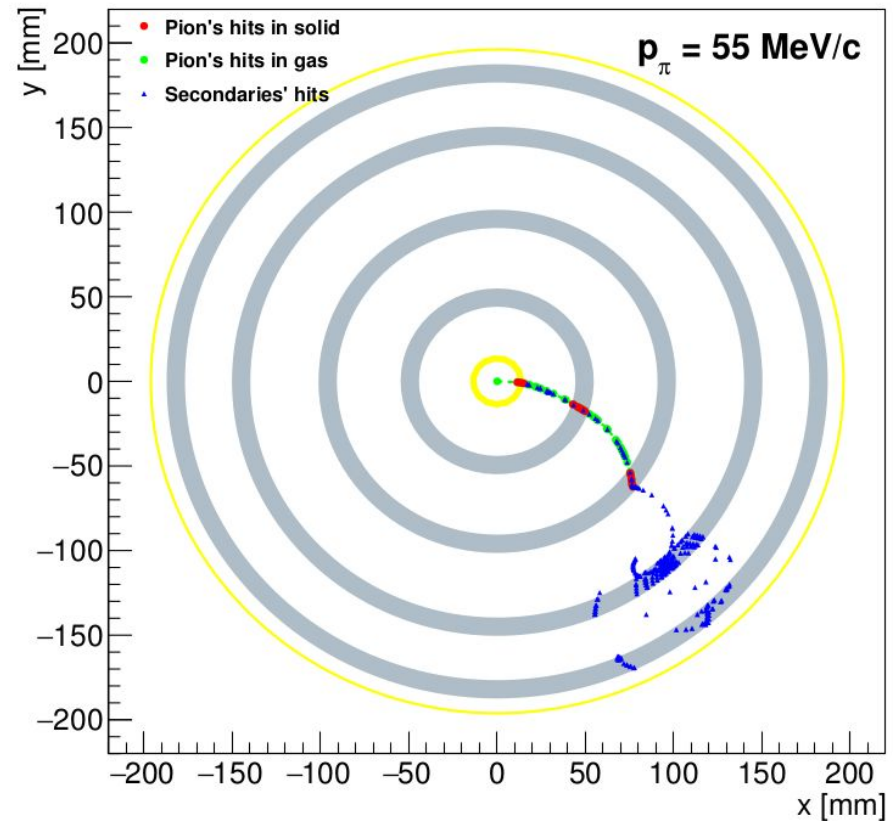
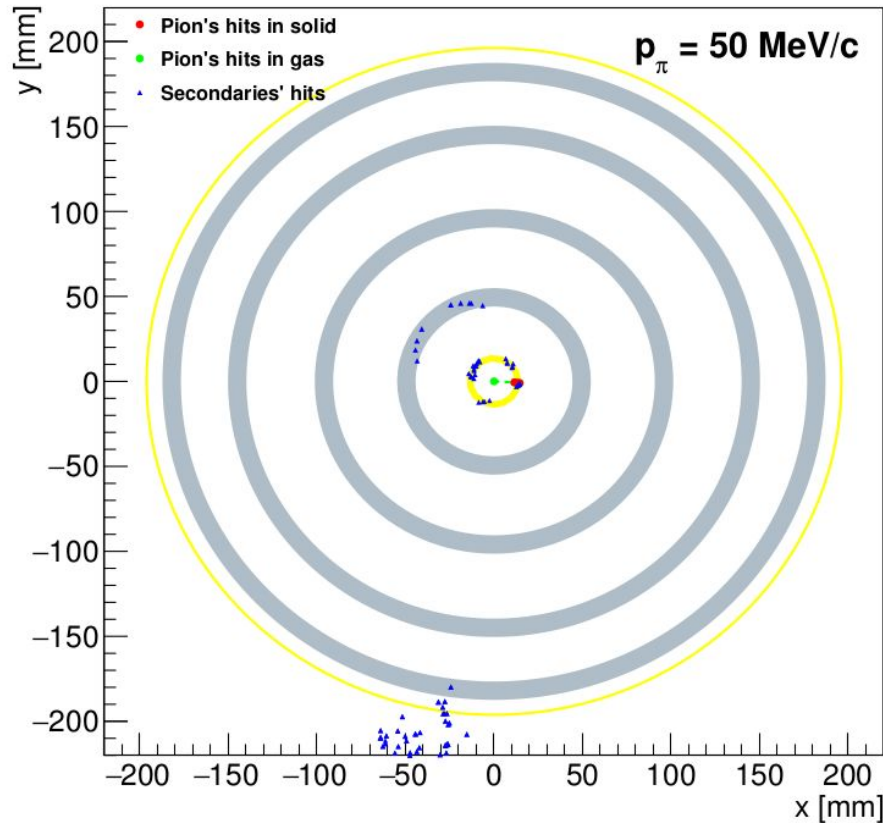

- Pions with momenta less than 50 MeV/c do not pass through the beampipe
- Starting from $p_\pi = 55 \text{ MeV/c}$ two layers can be reached by pions

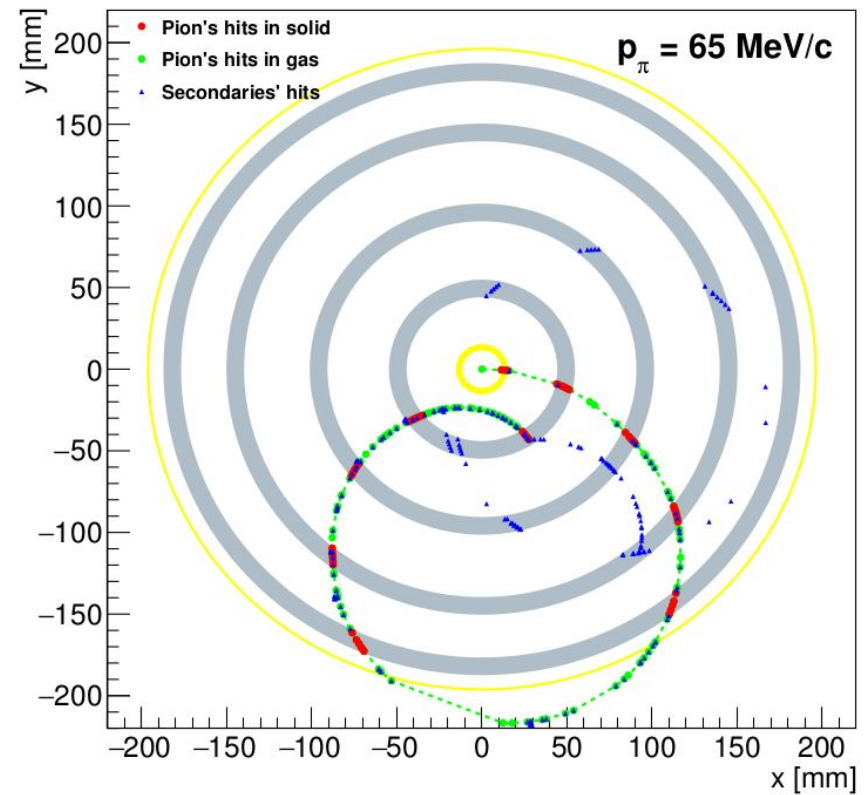
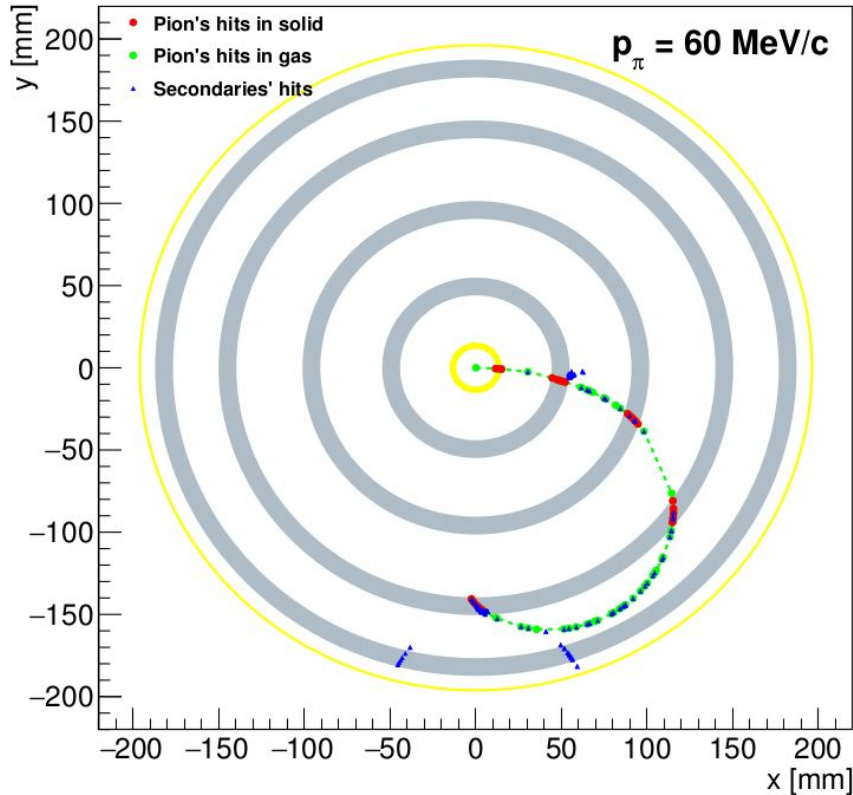

- Pions with momenta 60 MeV/c pass through three layers and curve back
- Starting from $p_{\pi} = 65 \text{ MeV/c}$ the all 4 layers are crossed by pions minimum twice

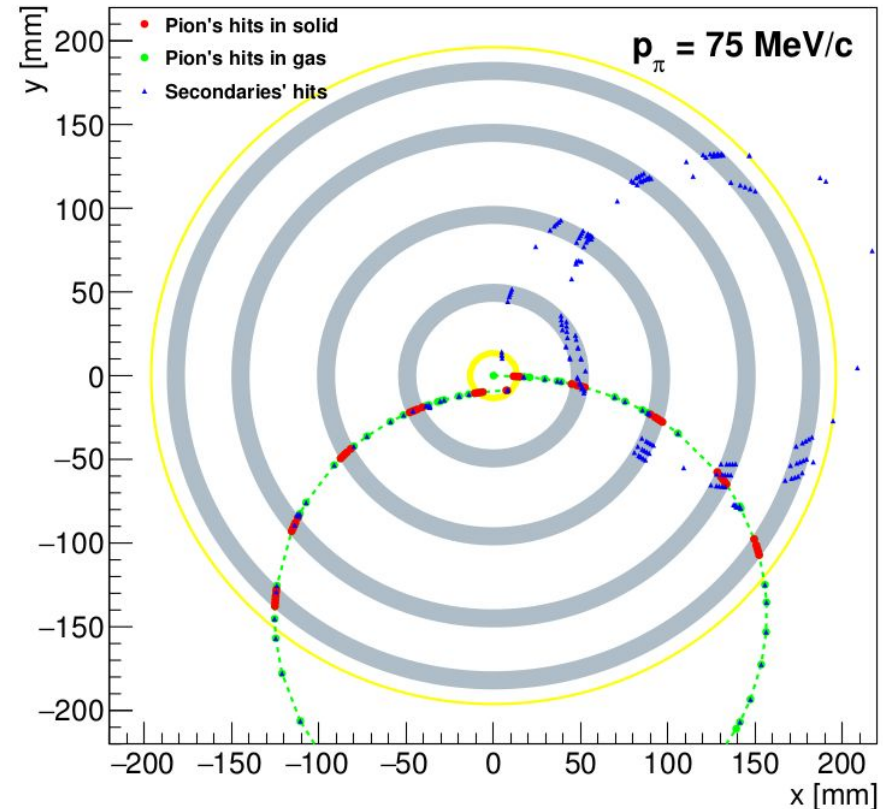
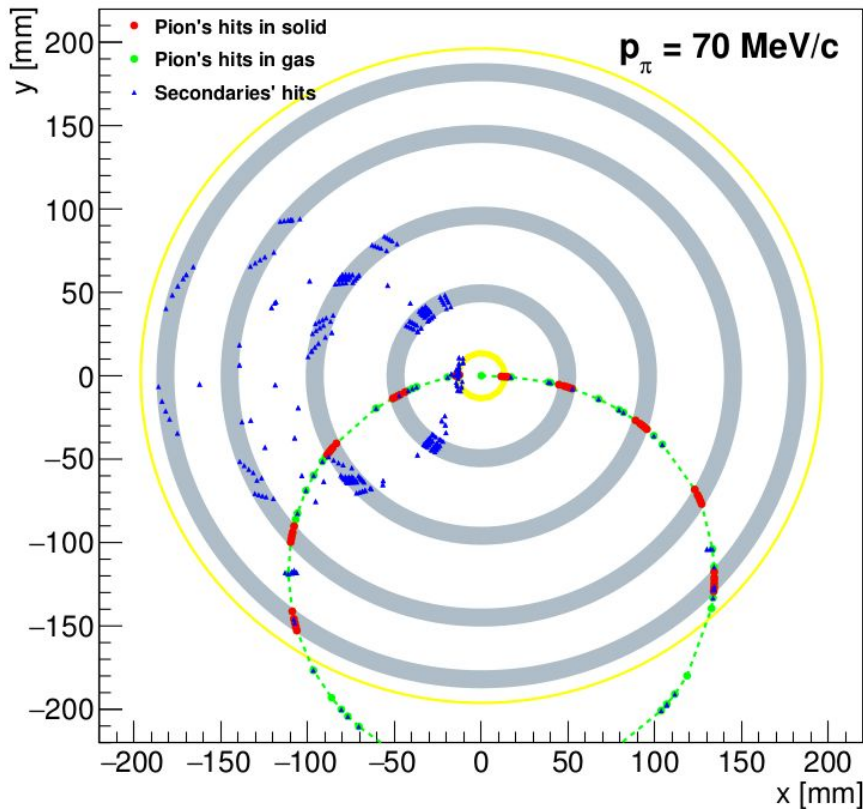

- Pions can be registered precisely for momentum, greater than 70 MeV/c in case of their transverse motion

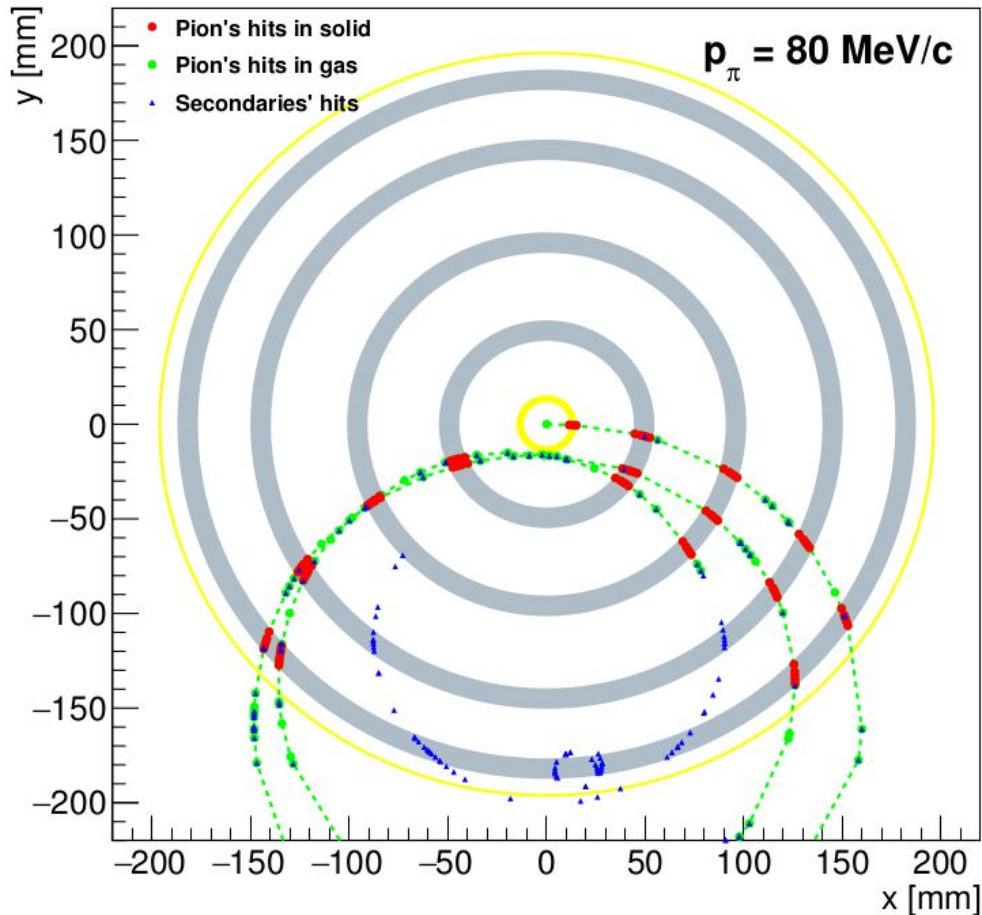

The reconstruction of pions with hits in 4 layers for CGEM option of Inner Tracker is possible for pions with momentum, greater than 60 MeV/c

Inner Tracker

TPC

- Two walls - inner and outer
 - Two suboptions of TPC
 - Standard: 2 X(1 mm G10 + 0.1 mm Teflon + 15 μ m Copper)
 - Standard outer + thin inner wall (50 μ m Kapton + 0.1 mm Teflon + 5 μ m Copper)
- Gas Ar(80%)-CO₂(20%)
- Magnetic field 1.5 T
- Pions with different momenta were gun perpendicular to beam axis

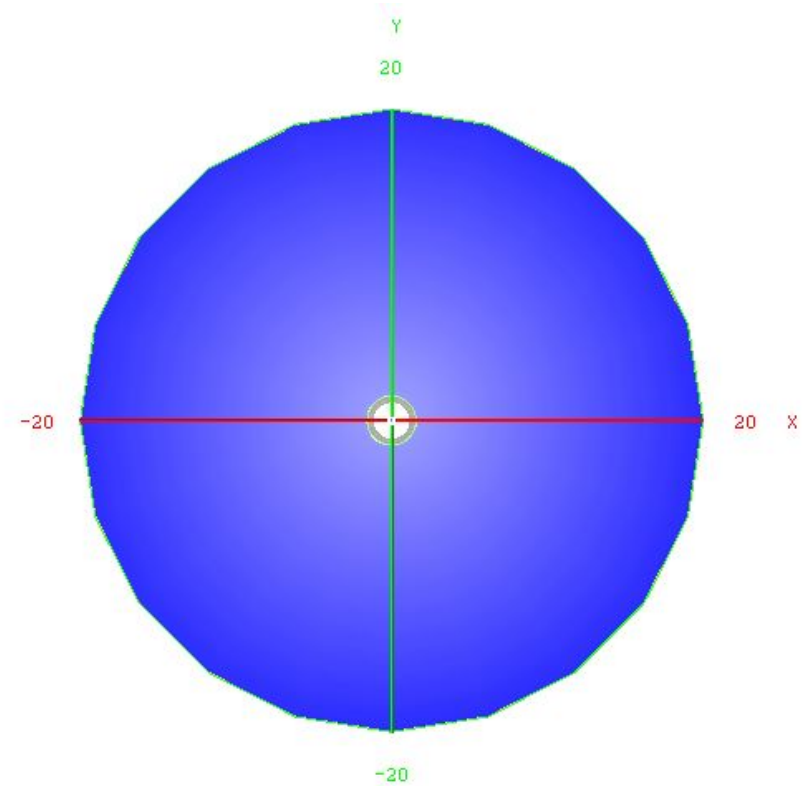
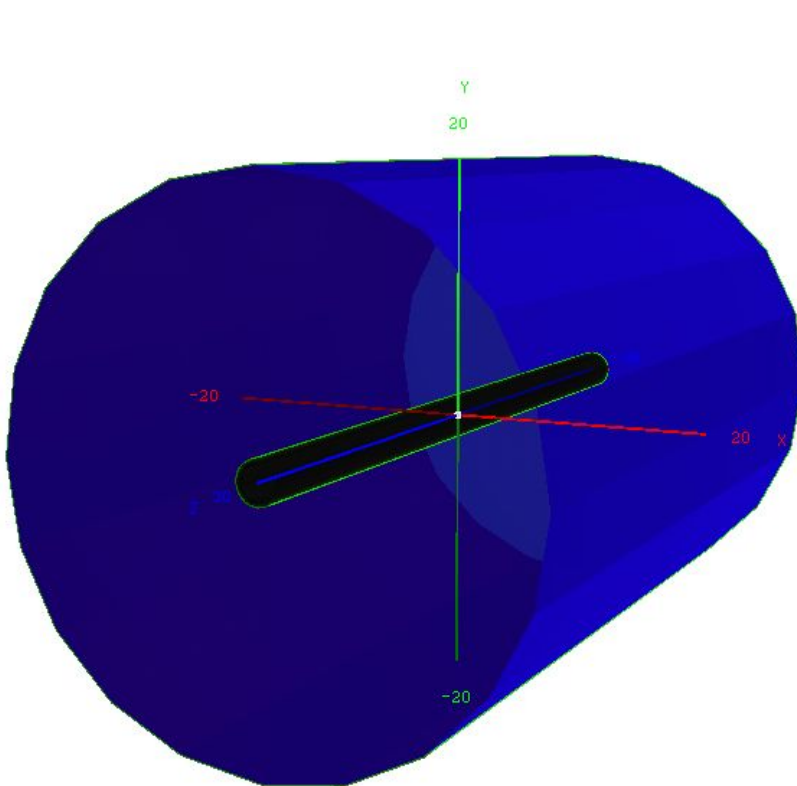

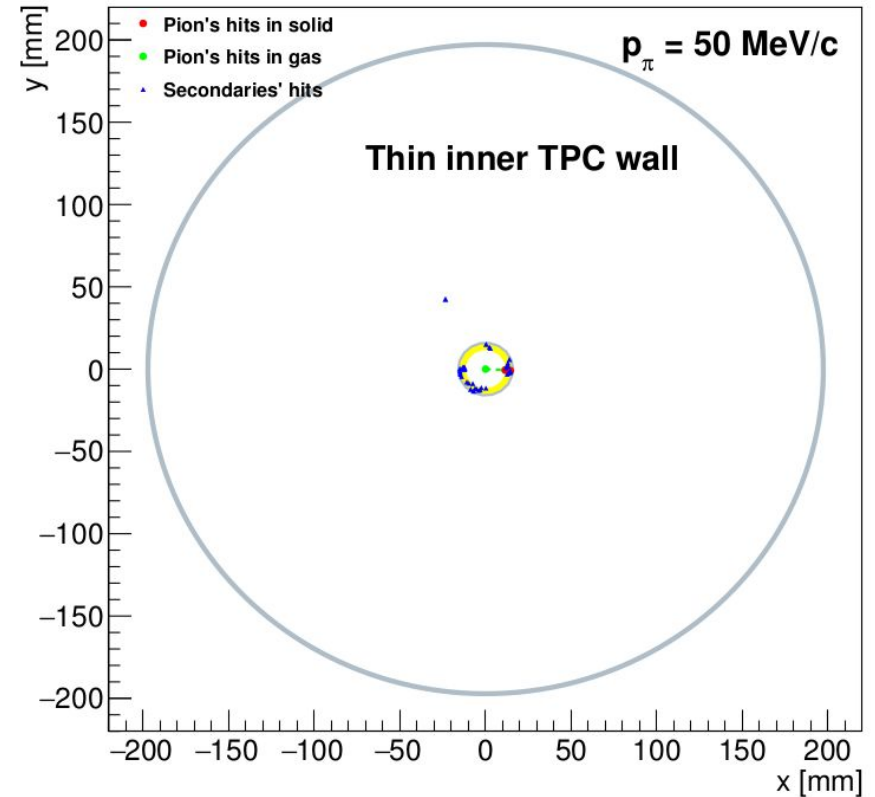
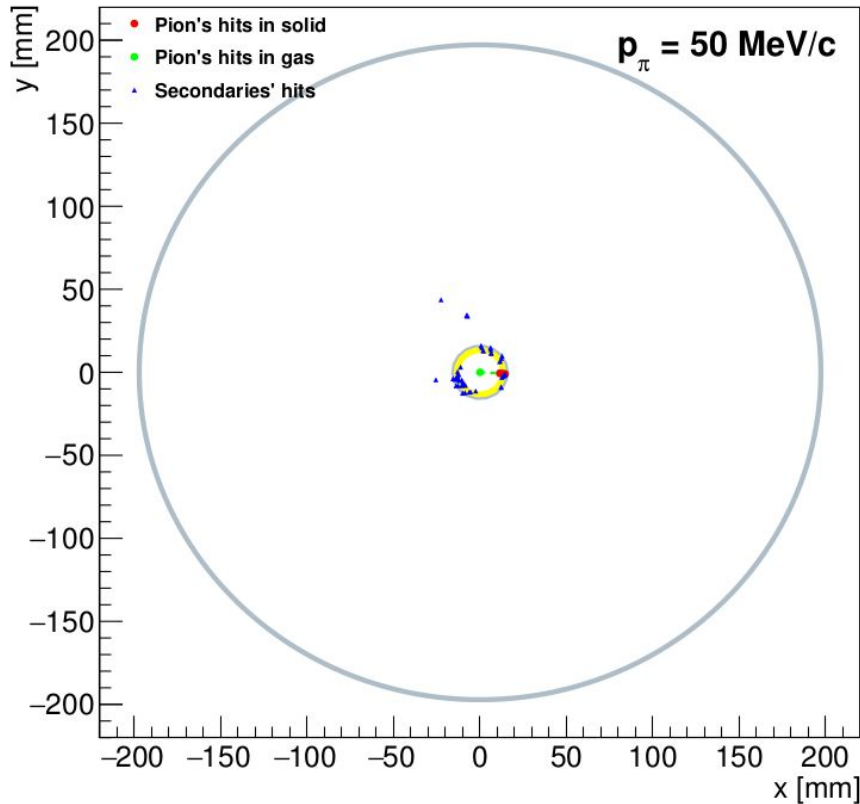

- Pions with momenta less than 50 MeV/c do not pass through the beampipe and, apparently, through the inner wall of TPC

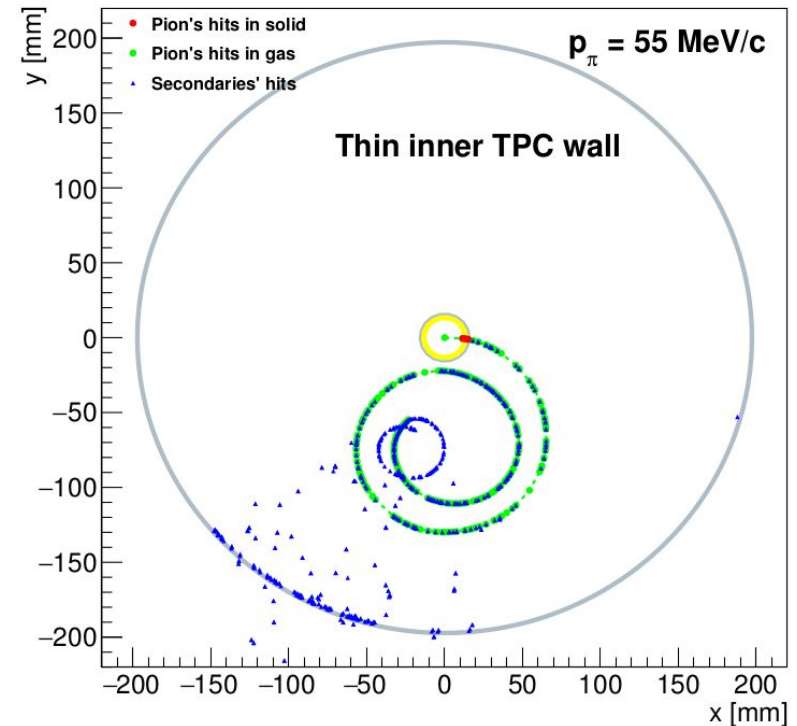
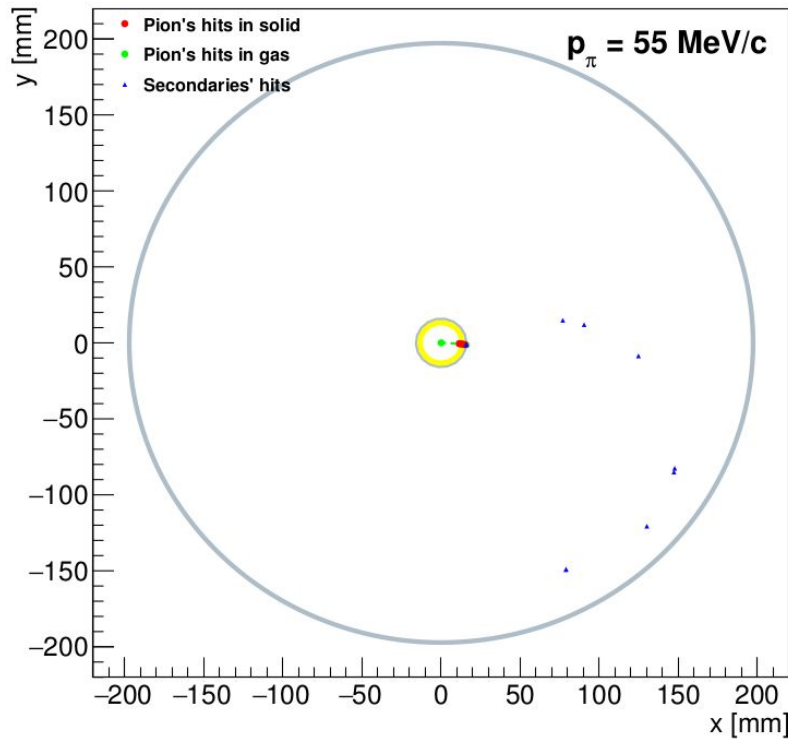

- Pions with momenta greater than 55 MeV/c pass through thin inner wall but they do not pass through standard inner wall

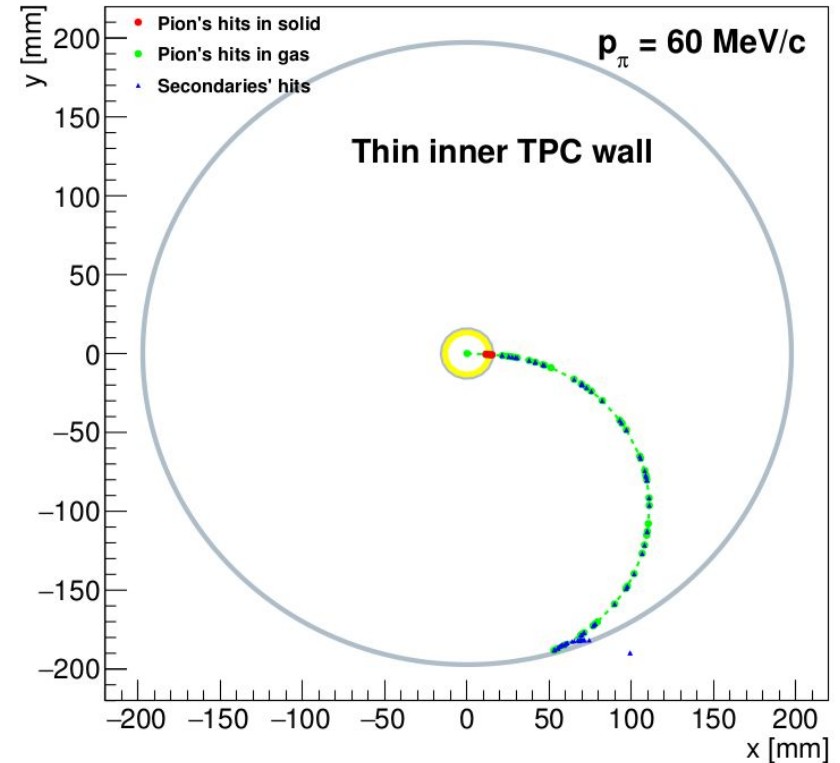
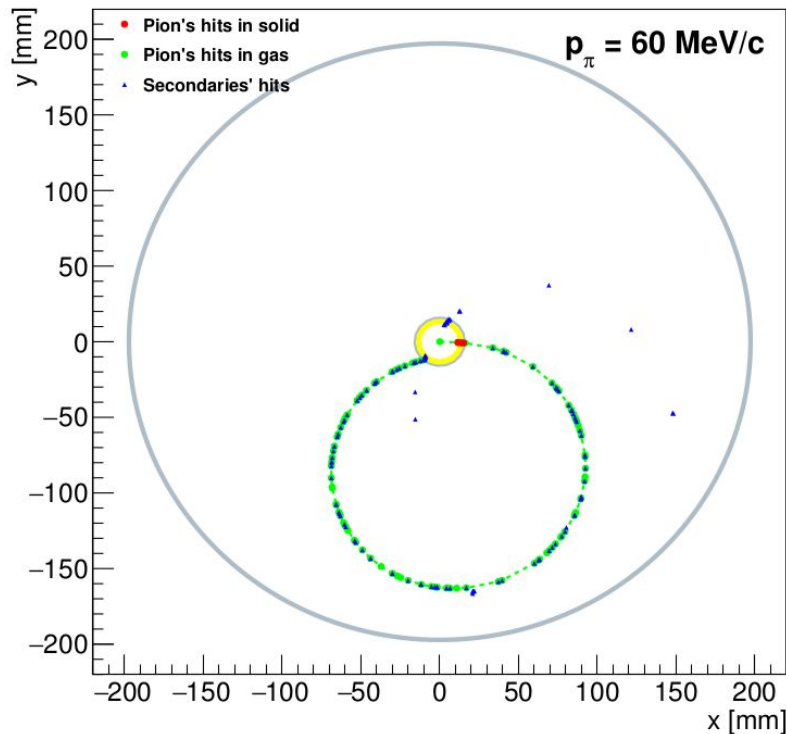

- Pions with momenta greater than $60 \text{ MeV}/c$ can be reconstructed for both TPC suboptions

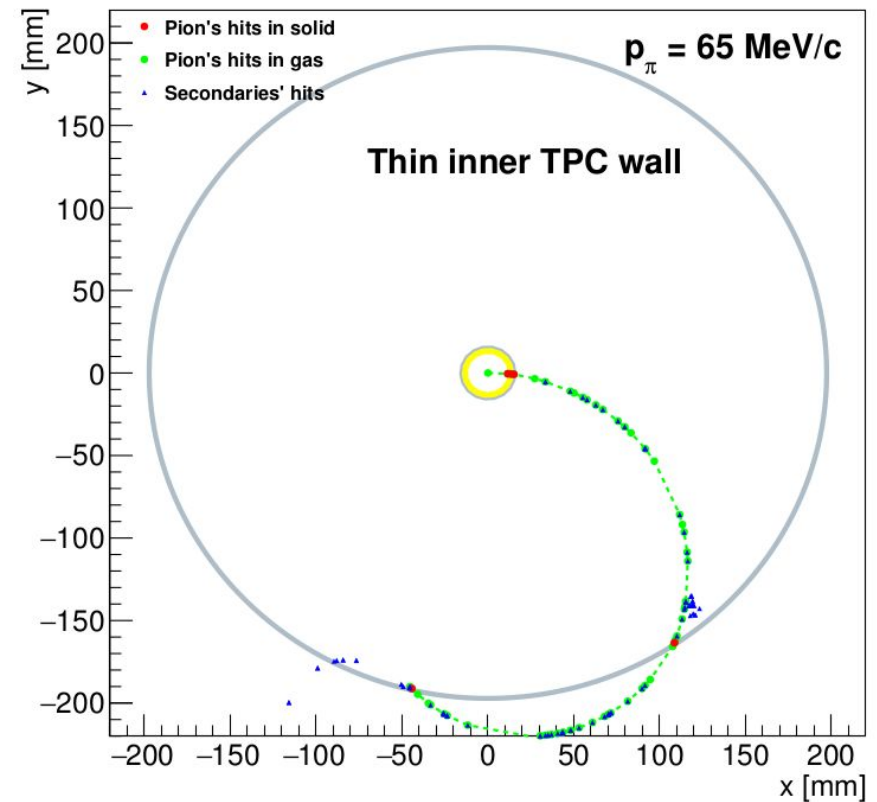
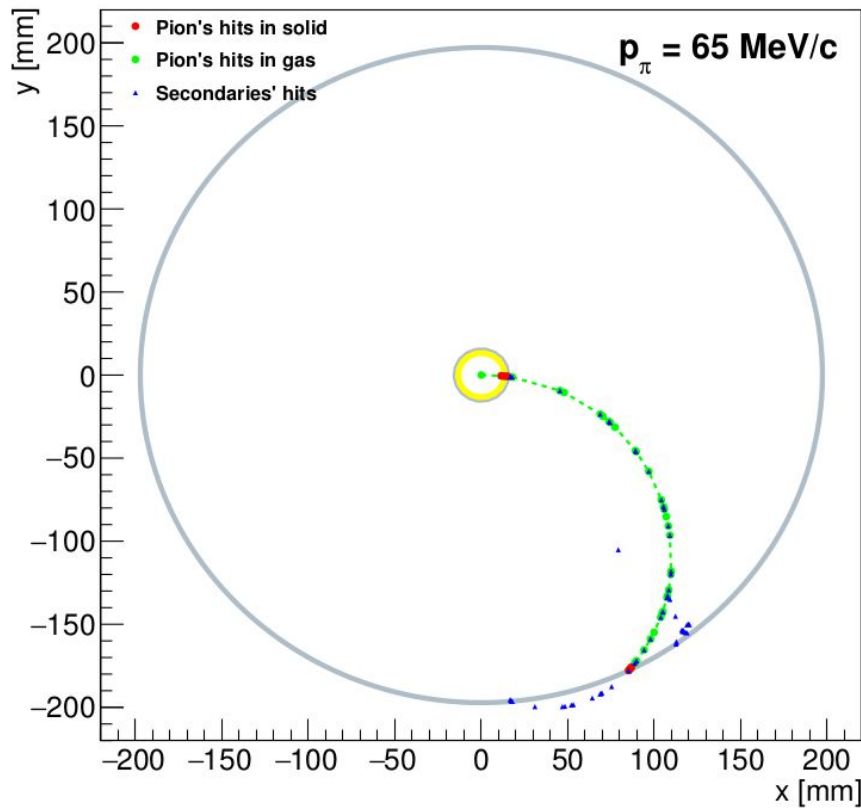

- Outer wall also influence the pions path in their further motion

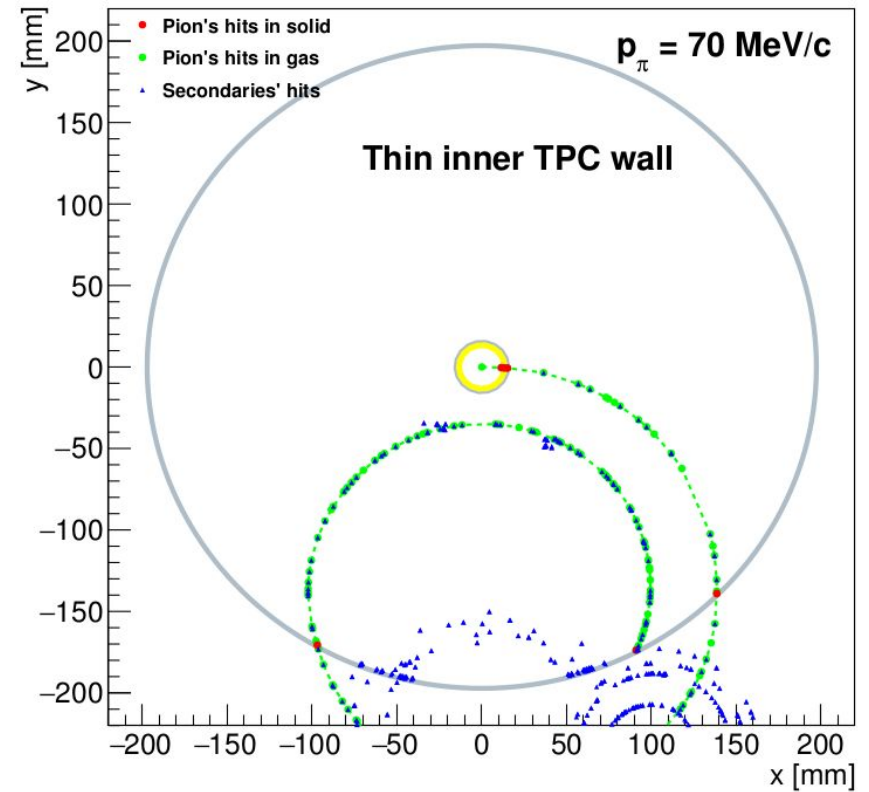
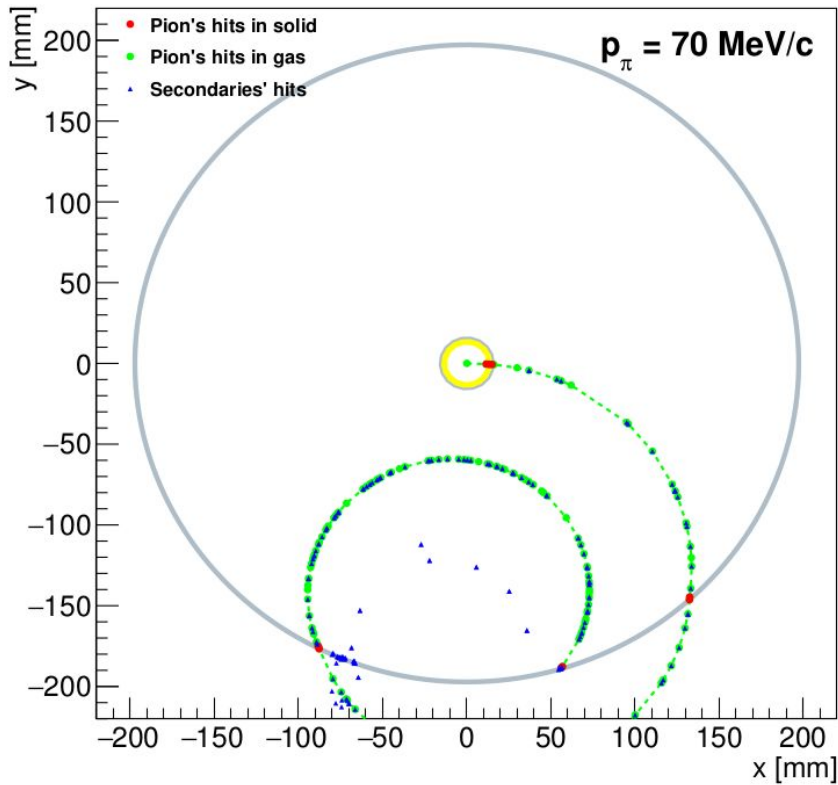

- Pions with momenta, higher than 70 MeV/c reach the outer wall minimum thrice

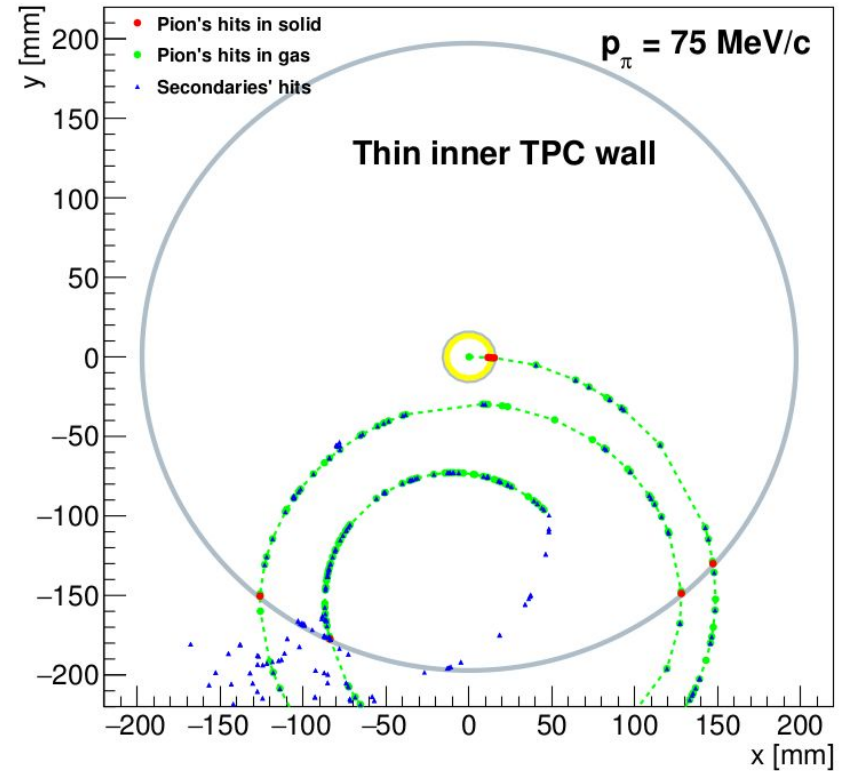
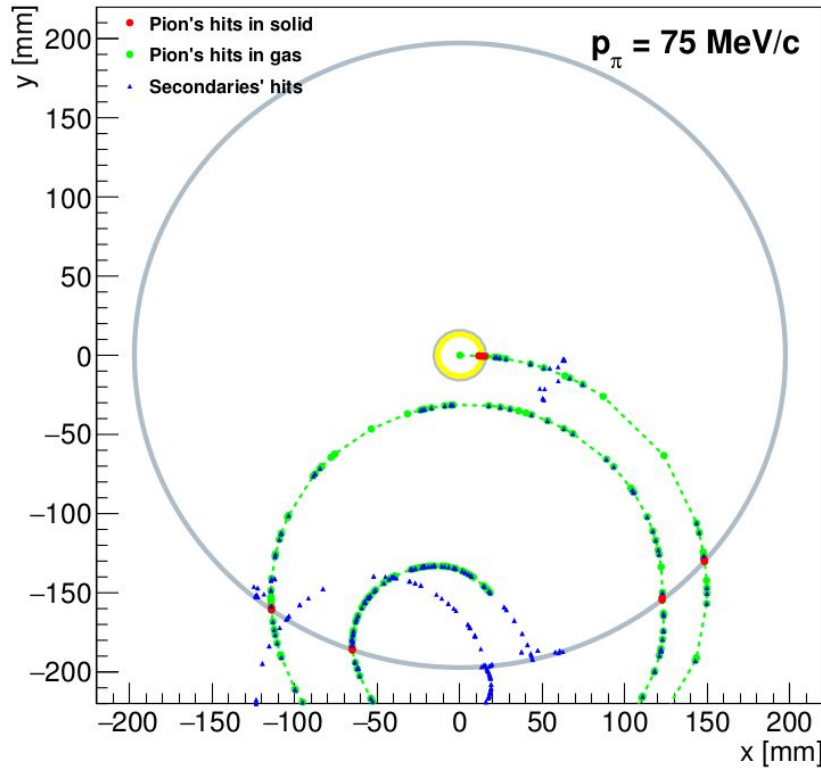

- Soft electrons leave a lot of ionization in the volume

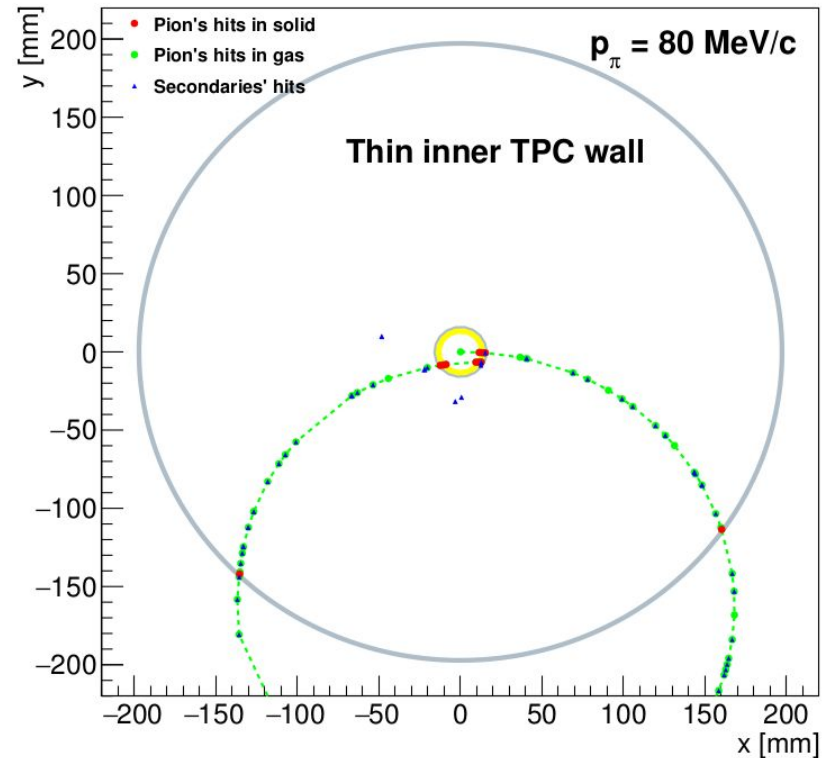
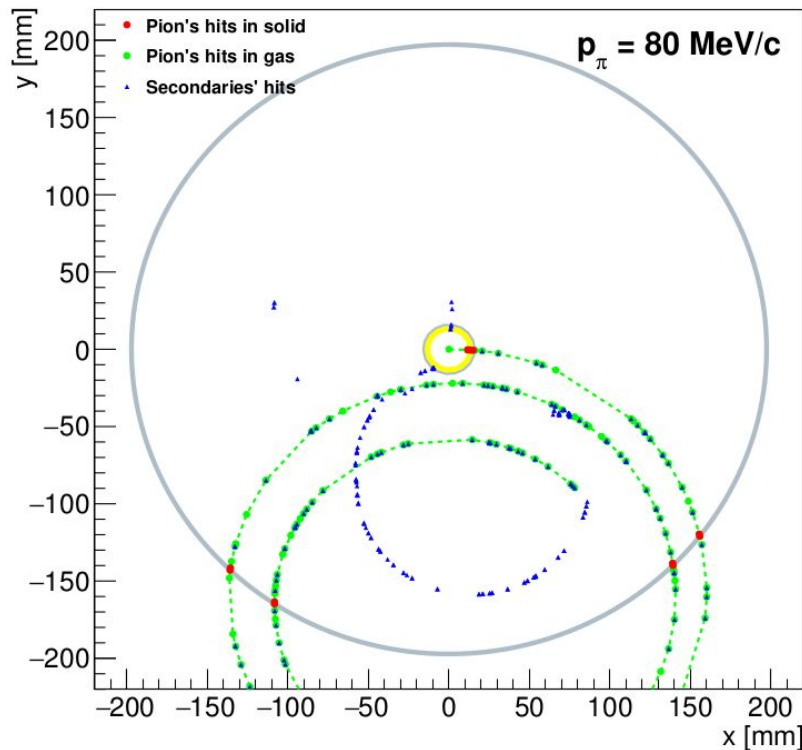

The reconstruction of pions for TPC option of Inner Tracker is possible:

- For standard wall suboption — $p_{\pi} > 60 \text{ MeV/c}$
- For thin wall suboption — $p_{\pi} > 55 \text{ MeV/c}$

Inner Tracker and pions spectra

Approximate momentum border demonstrating the pions, which can be reconstructed with the present tracking techniques

Simulation of π^+ transverse momentum distribution in $e^+e^- \rightarrow DD^*$ (V. Vorobyev)

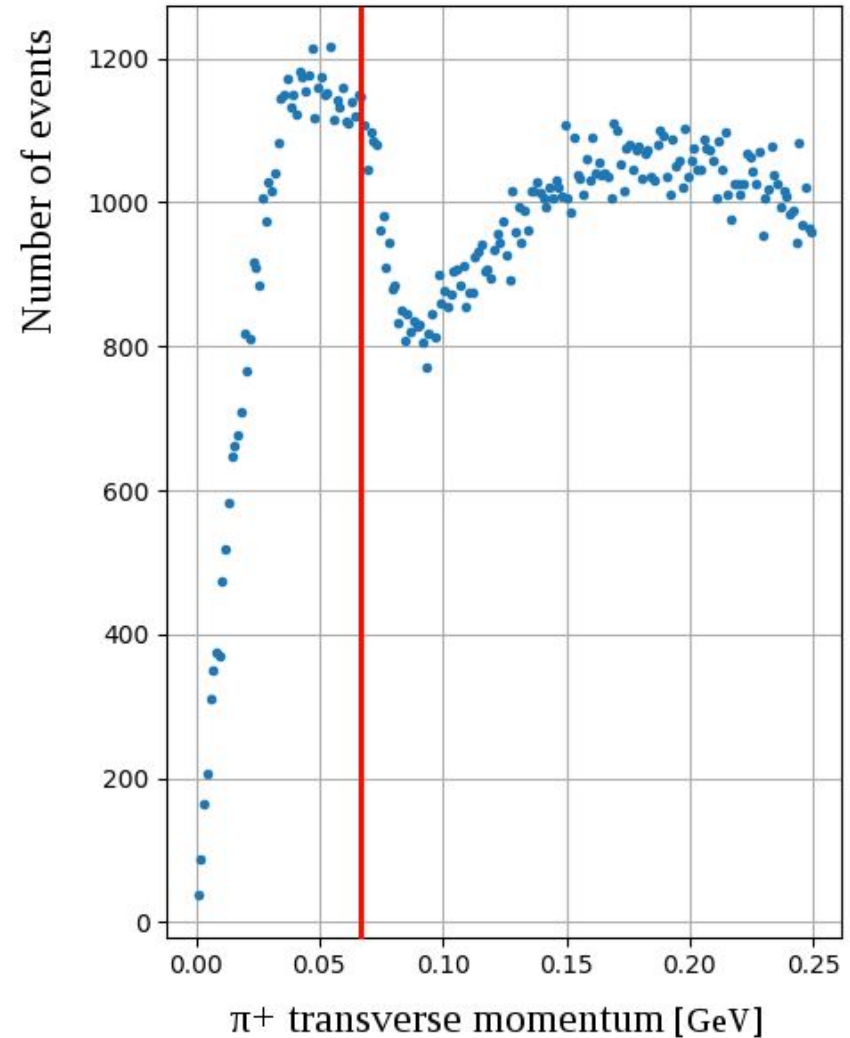

Conclusions

- Full simulation of Super Charm-Tau Inner Tracker with DD4hep is accomplished
- Pions with momenta less than 50 MeV/c do not pass through the beampipe
- Three options of Inner Tracker are considered
 - Si-strips — reconstruction for $p_{\pi} > 65$ MeV/c
 - CGEM — reconstruction for $p_{\pi} > 60$ MeV/c
 - TPC
 - Standard wall — reconstruction for $p_{\pi} > 60$ MeV/c
 - Thin wall — reconstruction for $p_{\pi} > 55$ MeV/c
- Next stage in simulation is study of reconstruction efficiency in presence of background according to the presentation of Lev Shekhtman

Merci pour votre attention!

Back-up

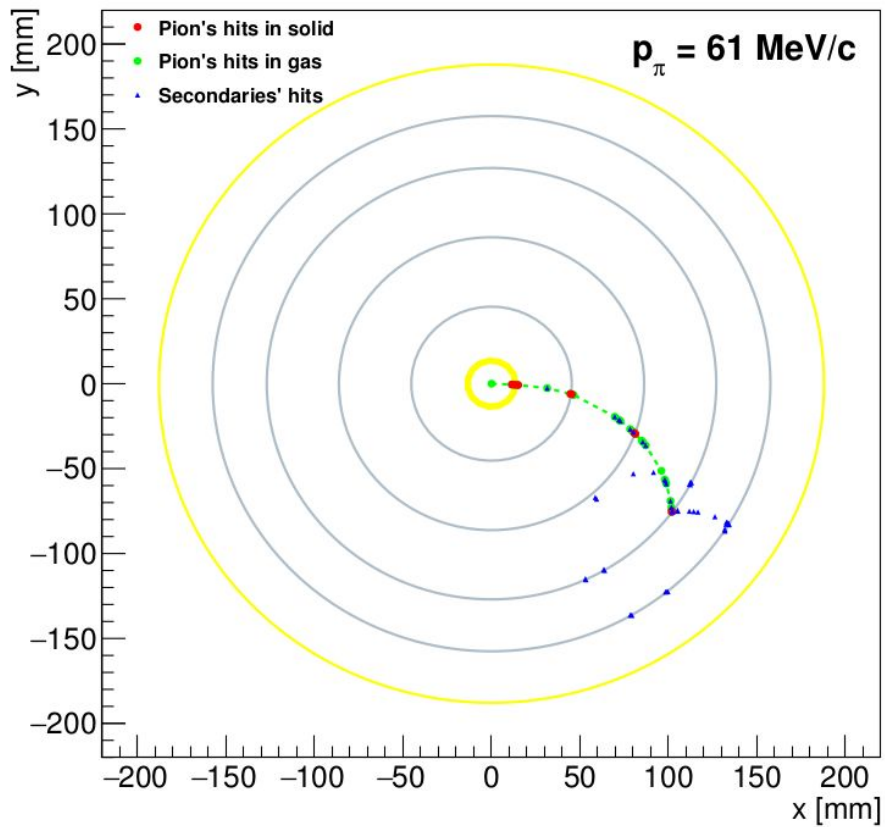

Si-strips

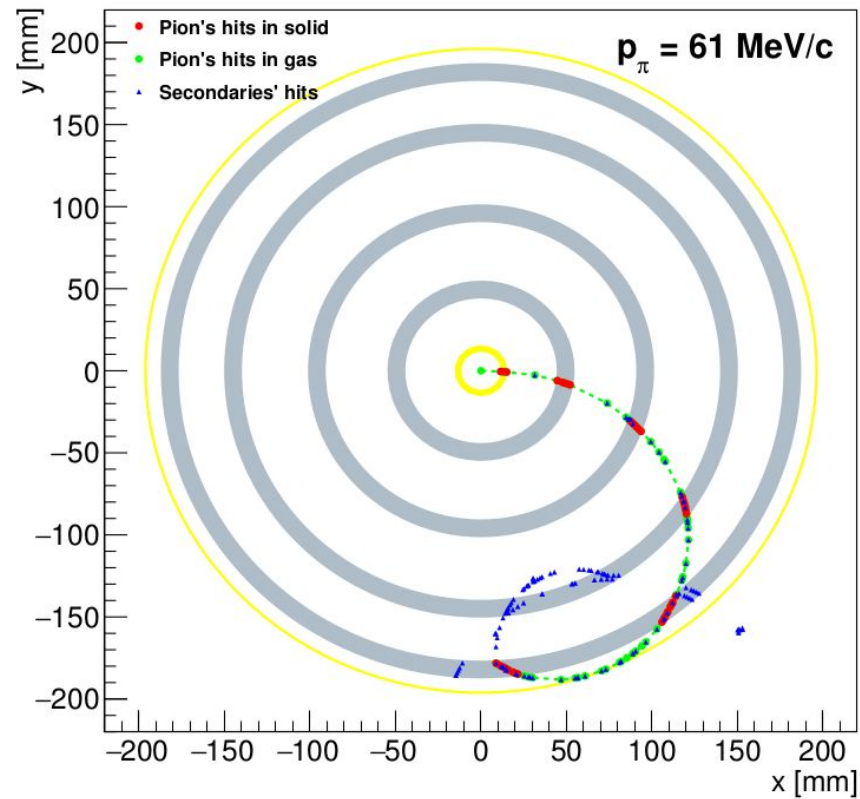

CGEM